

MODEL: 27-GEL
VOLTAGE: 12
DIMENSIONS: Inches (mm)
BATTERY: VRLA GEL
COLOR: Maroon (case) Grey (cover)
MATERIAL: Polypropylene
WATERING SYSTEM: N/A



PRODUCT SPECIFICATIONS

BCI GROUP SIZE	TYPE	CAPACITY ^A Minutes @25 Amps	CAPACITY ^B Amp-Hours (AH)				ENERGY (kWh) 100-Hr Rate	TERMINAL Type ^E	DIMENSIONS ^C Inches (mm)			WEIGHT lbs. (kg)
			5-Hr Rate	10-Hr Rate	20-Hr Rate	100-Hr Rate			Length	Width	Height ^D	
12 VOLT DEEP CYCLE GEL BATTERY												
27	27-GEL	179	76	84	91	100	1.20	7	12.73 (323)	6.38 (162)	9.26 (235)	63 (29)

- A. The number of minutes a battery can deliver when discharged at a constant rate at 80°F (27°C) and maintain a voltage above 1.75 V/cell. Capacities are based on peak performance.
 - B. The amount of amp-hours (AH) a battery can deliver when discharged at a constant rate at 77°F (25°C) for Gel Lines and maintain a voltage above 1.75 V/cell. Capacities are based on peak performance.
 - C. Dimensions are based on nominal size. Dimensions may vary depending on type of handle or terminal.
 - D. Dimensions taken from bottom of the battery to the highest point on the battery. Heights may vary depending on type of terminal.
 - E. Terminal images are representative only.
- Trojan's battery testing procedures adhere to both BCI and IEC test standards.

CHARGING INSTRUCTIONS

CHARGER VOLTAGE SETTINGS (AT 77°F/25°C)

System Voltage	12V	24V	36V	48V
Absorption Charge	14.1 – 14.4	28.2 – 28.8	42.3 – 43.2	56.4 – 57.6
Float Charge	13.5	27	40.5	54

Do not install or charge batteries in a sealed or non-ventilated compartment. Constant under or overcharging will damage the battery and shorten its life as with any battery.

CHARGING TEMPERATURE COMPENSATION

.028 VPC for every 10°F (5.55°C) above or below 77°F (25°C) (add .028 VPC for every 10°F (5.55°C) below 77°F and subtract .028 VPC for every 10°C above 77°F).

OPERATIONAL DATA

Operating Temperature	Self Discharge
-4°F to 113°F (-20°C to +45°C). At temperatures below 32°F (0°C) maintain a state of charge greater than 60%.	Less than 3% per month depending on storage temperature conditions.

Batteries may be utilized at higher temperatures with the understanding that battery life will be reduced by 50% for every 10° C (18° F) increase in operating temperatures over 68° F (20° C).

TERMINAL CONFIGURATIONS

7	UT	Universal Terminal
	<i>Terminal Height Inches (mm)</i>	
	1.10 (28)	
	<i>Torque Values in-lb (Nm)</i>	
	95-105 (11 - 12)	
		<i>Bolt</i>
		5/16"

BATTERY DIMENSIONS (shown with UT)

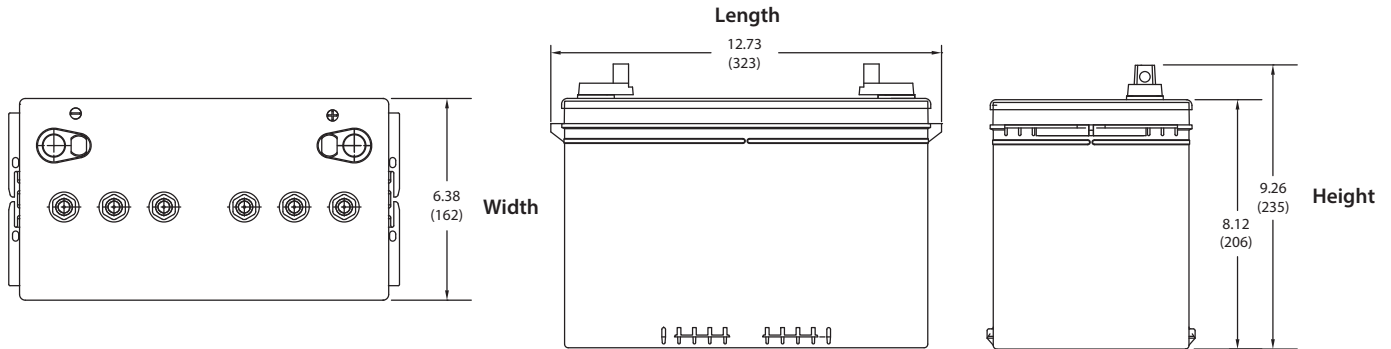

TROJAN 27-GEL PERFORMANCE

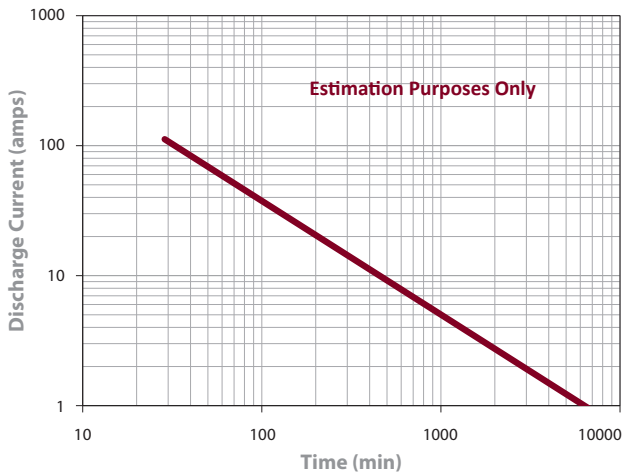

PERCENT CAPACITY VS. TEMPERATURE

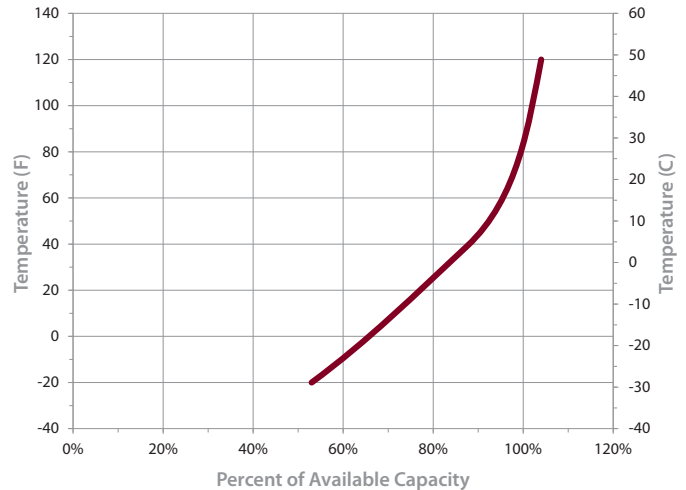

TROJAN BATTERY COMPANY WITH QUALITY SYSTEM CERTIFIED BY DNV
= ISO 9001:2008 =



Trojan batteries are available worldwide through Trojan's Master Distributor Network. We offer outstanding technical support, provided by full-time application engineers.

For a Trojan Master Distributor near you, call 800.423.6569 or + 1.562.236.3000 or visit www.trojanbattery.com

12380 Clark Street, Santa Fe Springs, CA 90670 • USA